

WILDERNESS SYSTEMS

OWNERS MANUAL





THANK YOU FOR CHOOSING A WILDERNESS SYSTEMS KAYAK.
GET READY TO EXPLORE YOUR WORLD WITHOUT BOUNDARIES.

This is not just any kayak. It's the right kayak. Attention to detail, performance, and quality have made this the number one choice for enthusiasts year after year.

Your premium kayak will provide you many years of enjoyment. We hope you take advantage of all the adventure that awaits you.

CONTENTS

- 3 Kayak Anatomy
- 4 Outfitting
- 5 Rudder Installation
- 6 Phase 3[®] AirPro MAX Seating System
- 8 Phase 3[®] AirPro Seating System
- 14 Storage
- 15 Transportation
- 16 Care & Maintenance
- 17 Safety
- 18 Accessories
- 20 Limited Lifetime Warranty
- 21 Service & Support

SIT ON TOP

- A:** Carry handle
- B:** Tankwell with bungee
- C:** SlideTrax accessory system*
- D:** Seating system
- E:** Cargo hatch
- F:** Footbraces
- G:** Self-bailing scupper tubes
- H:** Optional rudder location*

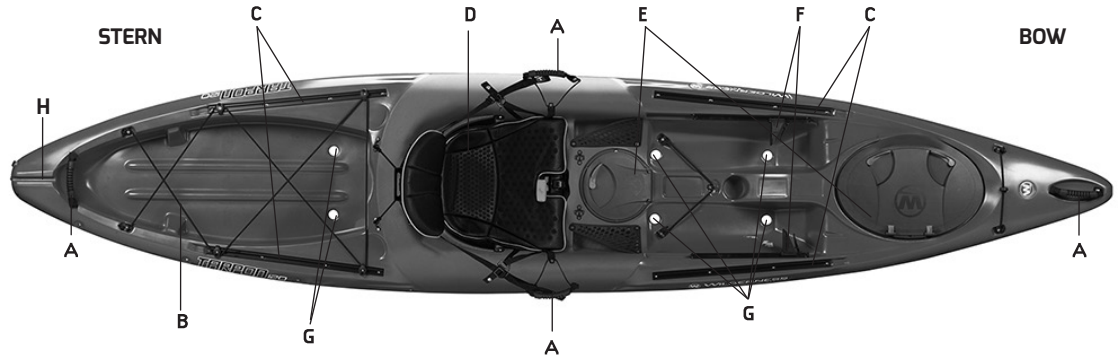

SIT INSIDE

- A:** Carry handles
- B:** Cargo hatches
- C:** Seating system
- D:** Safety lines
- E:** Bungee
- F:** Footbraces
- G:** Thighbraces
- H:** Cockpit coaming
- I:** Optional rudder location*

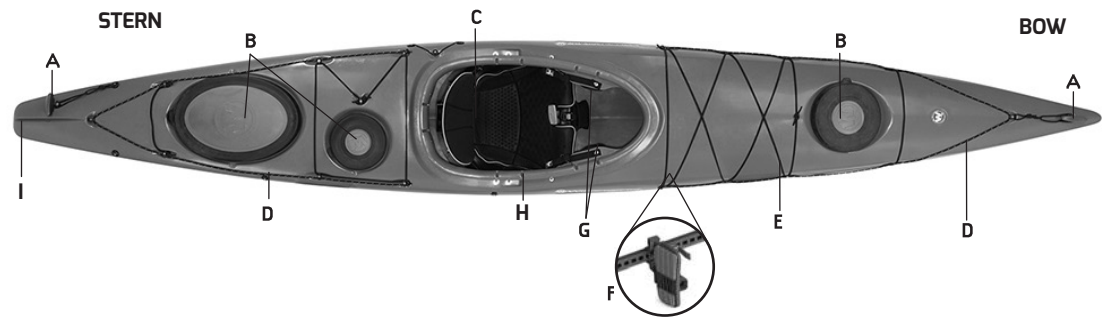

*Not available on all models

ORBIX HATCH COVERS

Lever-release open and close.

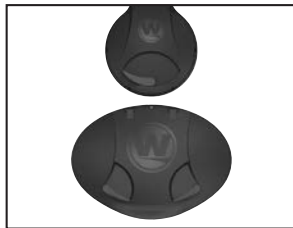

RUBBER DOME HATCHES

To remove the covers, find the tab and peel off. To replace the cover, line up ends first and then sides. Then hook it under the hatch rim and press it on firmly the entire way around. Sealed bulkheads, if equipped, add flotation and dry storage to the hatch area.

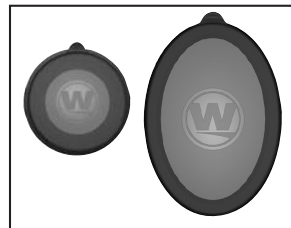

KEEPERS XL FOOTBRACES

The adjustment lever is located on the backside of the footpedal. To adjust, squeeze the lever and slide the footpeg to the desired location. Release the lever to lock it in place.

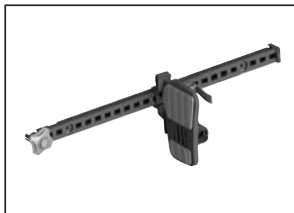

SLIDELOCK XL FOOTBRACES

The SlideLock Footbrace system is easy to access from inside the boat. Find the black plastic rod that is on the side of the cockpit extending from the footbrace. Lift it up and slide forward or back so your foot is resting comfortably on the footpeg and there is a slight bend in your leg. Release the rod to drop into position locking the footbrace.

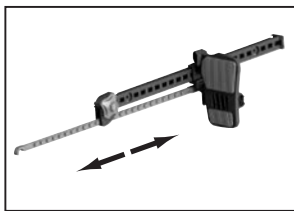

USING THE RUDDER SYSTEM

Some kayaks come with an optional factory rudder system included. After market rudder systems are also available. **Please contact your local dealer for any questions regarding setup or installation, or visit WildernessSystems.com for video instruction.**

Once your rudder is installed, use the lift line (located on the right side of the boat, towards the rear of the cockpit) to drop the rudder into the water by pulling it forward.

To operate the rudder, use the footbrace pedals. To maintain a straight position, both pedals should be even with each other. To steer the kayak right, push the right pedal down similarly to a gas pedal. To steer the kayak left, push the left pedal down.

INSTALLING THE RUDDER

INSTALL THE RUDDER BRACKET

- a. Remove the two filler screws on stern and set aside.
- b. With the raised “stop” pin facing up, align the bracket with the mounting holes in hull. Place ¼” lock washers (2 on each screw) over ¼-20 x 5/8” hex head screws and thread screws into mounting holes using the 3/16” Allen head wrench provided with owners’ manual.
- c. Start both screws before tightening either one completely. Tighten each screw fully.

INSTALL THE RUDDER

- a. Unwind the up-haul cord coiled around the rudder.
- b. Make sure the cord runs straight and true along the starboard (right) side of the kayak when viewed from the stern.
- c. Remove the ring pin from end of rudder post and insert post into bracket.
- d. Secure rudder in bracket by inserting ring pin in post below bracket.
- e. Test up-haul cord by pulling on top or bottom run of cord to raise or lower rudder. Learn which run raises and which run lowers rudder.

CONNECTING RUDDER CABLES

- a. Pull eyelet at end of each rudder cable back to line up with wings on rudder head.
- b. Remove the ring pin from rudder head and lift pin from rudder head. Make sure to attach right side cable end to right side of rudder head.
- c. Place eyelet on end of rudder cable on top of wing on rudder head and insert pin. Secure pin with ring pin. Repeat on other side.

SECURE RUDDER TO KAYAK

- a. Center rudder blade and then raise it so it flips over end of kayak and settles into notch on deck. A variety of rudder lock-downs are used to secure rudder to deck and these should be put in place to secure rudder when transporting on top of your vehicle.
- b. Make sure to release lock-down before entering your kayak to go paddling.

INTRODUCING PHASE 3 AIRPRO MAX - RIDE

The new Phase 3 AirPro MAX high/low seating system is poised to give kayak anglers the competitive advantage they need to sight fish from the seat of their Ride. The AirPro MAX preserves the popular innovations found in most Phase 3 seats – adjustability, comfort features and high-quality materials – yet it is a true advancement in design. Fully functional in existing Ride models with great ease of installation, the patent-pending seat has a full forward/aft trim range and three phase (high, low and recline) positioning without any clipping or loosening of straps. Standing room remains ample and the seat back can be folded and sat upon for even more height on the water. The aluminum tube frame construction is highly durable with an all-weather, breathable textile that affords both comfort and functionality. The injection molded slide rails provide a platform for adding gear with the ultimate accessibility.

AIRPRO MAX



Low Position



High Position



Recline Position

PHASE 3® AIRPRO MAX SEATING SYSTEM

Aluminum Tube Frame

Premium all-weather, breathable textile combining an open weave fabric with a 3D mesh filler for the ultimate in comfort.

Backrest straps allow for adjustments of the seat back angle.

Easy access grab handles allow the seat to adjust quickly to low, high or recline by unweighting the seat and shifting.

HIGH POSITION



Cam Rotational Pivots

Provisions have been made in the slide rail to easily attach accessories.

Forward/aft seat positioning in existing Ride models is preserved with a unique injection molded rail.

PHASE 3® AIRPRO SEATING SYSTEM

INTRODUCING PHASE 3 AIRPRO

The patented Phase 3 seating system has become the industry leader when it comes to an amazingly comfortable seat. And now it's even better.

Ergonomic elements have been added to all aspects of the AirPro. The contoured seat and seat backs have been designed with increased comfort in mind. Multiple-sized holes in the special foam padding produce varying densities to provide extra cushioning along the spine and under the legs while comfortably supporting the sit bones. The flexible back rest features a cutaway for spinal support and a dynamic structural design that conforms to and moves with your back; the seat's leg lifter area has a softer edge and is contoured under your thighs. The AirPro also features over the perforated foam, greatly improving ventilation so you and your seat breathe and dry out quickly.

Attention to ergonomic details is also evident in the easily accessible controls that have been carefully positioned to prevent strain by limiting your reach to adjust the system. Simple, highly visible icons easily identify the adjustment points and their functions. A re-designed leg lifter has now become the central control for adjusting both the seatback and leg lifter height. The leg lifter uses a pulley style system that greatly reduces the effort needed to position your legs for maximum comfort. With an easy pull on the web strap the seat back is lowered causing less friction on the bungee cord and preventing wear and tear. Located in front of the central controls is a mesh bag that can be used for storage.

Other new improvements include a new pad system that stays where you put it and no more plastic pine trees on the seat pad to cause pressure points during long paddles.



PHASE 3® AIRPRO



PHASE 3® AIRPRO SOT



PHASE 3® AIRPRO TOUR





PHASE 3® AIRPRO XP





AIRPRO FREEDOM ELITE - RIDE

PHASE 3 AIRPRO – ASPIRE, PUNGO & PAMLICO

- A** Position seat back for lumbar support while paddling or upper back support while relaxing, the Phase 3 AirPro backrest will conform to you providing all day comfort.
- B** Large comfort holes allow ventilation for air flow while providing cushioning to hard contact areas under the legs and along the spine.
- Smaller holes on the backrest provide ventilation and increased support to the oblique muscles while the holes in the seat pad support the sit bones and provide drainage for water.
- C** The backrest is lowered by pulling the nylon strap loop with the **D**  icon. Push the gray web cleat lever to release the strap and raise the backrest.
- The padded seat back adjusts forward and back with straps located on either side of the paddler with the **E**  icon. These straps are located next to the knee braces on Aspire and Pungo models or behind the seat for Pamlico models. Tighten the backrest by pulling forward on the nylon strap or loosen it by pulling on the black and silver finger pull loop. For good rotation while paddling it should not be too tight.
- F** The leg lifter height is adjusted with the gray handle and corresponding gray web cleat release levers; to raise the height of the leg lifter gently shift one's weight off of the leglifter while pulling the gray handle. To lower the leglifter press both gray web cleat levers simultaneously.
- G** The mesh bag located in front of the central controls can be used to store the leg lifter handle, seat height adjustment strap, a water bottle or any other items you would like to keep in easy reach.





PHASE 3 AIRPRO SOT – TARPON & THRESHER

- A** Position seat back for lumbar support while paddling or upper back support while relaxing, the Phase 3 AirPro backrest will conform to you providing all day comfort.
- B** Large comfort holes allow ventilation for air flow while providing cushioning to hard contact areas under the legs and along the spine.
- C** Smaller holes on the backrest provide ventilation and increased support to the oblique muscles while the holes in the seat pad support the sit bones and provide drainage for water.
- D** The backrest is lowered by pulling the nylon strap loop with the  icon. Push the gray web cleat lever to release the strap and raise the backrest.
- E** The padded seat back adjusts forward and back with straps located on either side of the paddler with the  icon. These straps are located near the hull on Tarpon models. Tighten the backrest by pulling forward on the nylon strap or loosen it by pulling on the black and silver finger pull loop. For good rotation while paddling it should not be too tight.
- F** The leg lifter height is adjusted with the gray handle and corresponding gray web cleat release levers; to raise the height of the leg lifter gently shift one's weight off of the leglifter while pulling the gray handle. To lower the leglifter press both gray web cleat levers simultaneously.
- G** The mesh bag located in front of the central controls can be used to store the leg lifter handle, seat height adjustment strap, a water bottle or any other items you would like to keep in easy reach.





PHASE 3 AIRPRO TOUR – POLARIS & TSUNAMI*

- A** Position seat back for lumbar support while paddling or upper back support while relaxing, the Phase 3 AirPro backrest will conform to you providing all day comfort.
- B** Large comfort holes allow ventilation for air flow while providing cushioning to hard contact areas under the legs and along the spine.
- C** Smaller holes on the backrest provide ventilation and increased support to the oblique muscles while the holes in the seat pad support the sit bones and provide drainage for water.
- D** The backrest is lowered by pulling the nylon strap loop with the  icon. Push the gray web cleat lever to release the strap and raise the backrest.
- E** The padded seat back adjusts forward and back with straps located on either side of the paddler with the  icon. These straps are located above the thighbraces on touring models. Tighten the backrest by pulling forward on the nylon strap or loosen it by pulling on the black and silver finger pull loop. For good rotation while paddling it should not be too tight.
- F** The leg lifter height is adjusted with the gray handle and corresponding gray web cleat release levers; to raise the height of the leg lifter gently shift one's weight off of the leglifter while pulling the gray handle. To lower the leglifter press both gray web cleat levers simultaneously.
- G** The mesh bag located in front of the central controls can be used to store the leg lifter handle, seat height adjustment strap, a water bottle or any other items you would like to keep in easy reach.



PHASE 3® AIRPRO SEATING SYSTEM

PHASE 3 AIRPRO XP – FOCUS, TEMPEST, TSUNAMI* & ZEPHYR

- A** Position seat back for lumbar support while paddling or upper back support while relaxing, the Phase 3 AirPro backrest will conform to you providing all day comfort.
- B** Large comfort holes allow ventilation for air flow while providing cushioning to hard contact areas under the legs and along the spine.
- C** Smaller holes on the backrest provide ventilation and increased support to the oblique muscles while the holes in the seat pad support the sit bones and provide drainage for water.
- D** To adjust the height of the backband; tighten or loosen the two web straps extending from the backband to the cockpit rim. Pull the web loop strap located at the front of the seat with the  icon to hold the backband in place or press the gray web cleat lever to loosen.
- E** To adjust the backstrap fit, tighten or loosen the two nylon web loop straps with the  icon. The straps are anchored above the thigh braces. Further adjustment can be achieved by using the web loop straps located behind the backband.
- F** The leg lifter height is adjusted with the gray handle and corresponding gray web cleat release levers; to raise the height of the leg lifter gently shift one's weight off of the leglifter while pulling the gray handle. To lower the leglifter press both gray web cleat levers simultaneously.
- G** The mesh bag located in front of the central controls can be used to store the leg lifter handle, backband height adjustment strap, a water bottle or any other items you would like to keep in easy reach.



The adjustable thigh pads found on some touring and sea kayak models are adjusted by removing the front screw and loosening the back screw. Slide the thigh pad forward or back and in and out to find a comfortable position. Replace the screws and tighten. A good position for the thigh pad is a couple of inches in front of your kneecap or where it's most comfortable.

PHASE 3 AIRPRO FREEDOM ELITE – COMMANDER & RIDE*

- A** Position seat back for lumbar support while paddling or upper back support while relaxing, the Phase 3 AirPro backrest will conform to you providing all day comfort.
- B** Large comfort holes allow ventilation for air flow while providing cushioning to hard contact areas under the legs and along the spine.
- C** Smaller holes on the backrest provide ventilation and increased support to the oblique muscles while the seat pad support the sit bones and provide drainage for water.
- D** The padded seat back adjusts forward and back with straps located on either side of the paddler with the  icon. These straps are located near the seat on Ride models. Tighten the backrest by pulling forward on the nylon strap or loosen it by pulling on the black and silver finger pull loop. For good rotation while paddling it should not be too tight.
- E** The leg lifter height is adjusted with the gray handle and corresponding gray web cleat release levers; to raise the height of the leg lifter gently shift one's weight off of the leglifter while pulling the gray handle. To lower the leglifter press both gray web cleat levers simultaneously.
- F** The mesh bag located in front of the central controls can be used to store the leg lifter handle, seat height adjustment strap, a water bottle or any other items you would like to keep in easy reach.



STORAGE

SHORT TERM STORAGE

Be sure to empty the kayak of all water. The kayak may be stored on its side or in a vertical position temporarily. Storage in these positions for an extended period of time could cause flattening or deformation in the side of the hull.

LONG TERM STORAGE

In addition to emptying all water out, you should clean the kayak by rinsing with freshwater especially if the kayak has been used in salt water or becomes muddy. Store out of direct sunlight and indoors, if possible. UV exposure can shorten the lifespan of any kayak and can degrade its finish. Kayaks can be stored slung on their sides via web straps, positioned 1/3 of the way along the hull (as shown). Be sure to not leave straps or ropes tightly wound around the hull for extended periods of time as it may cause deformation.

Your kayak can also be stored hull up (as shown) on parallel bars with weight supported evenly throughout its length. For large cockpit (recreational) boats, position the bars so that the cockpit coaming rests on the bars. For smaller cockpit kayakers, position bars so that they contact the deck between the cockpit and any hatches.

CAUTION:

Do not suspend your kayak by using the grab loops at either end of the boat. This can cause the hull to distort over time.

IMPORTANT:

Commander Series requires special storage instructions. Please see separate Commander Series Addendum.

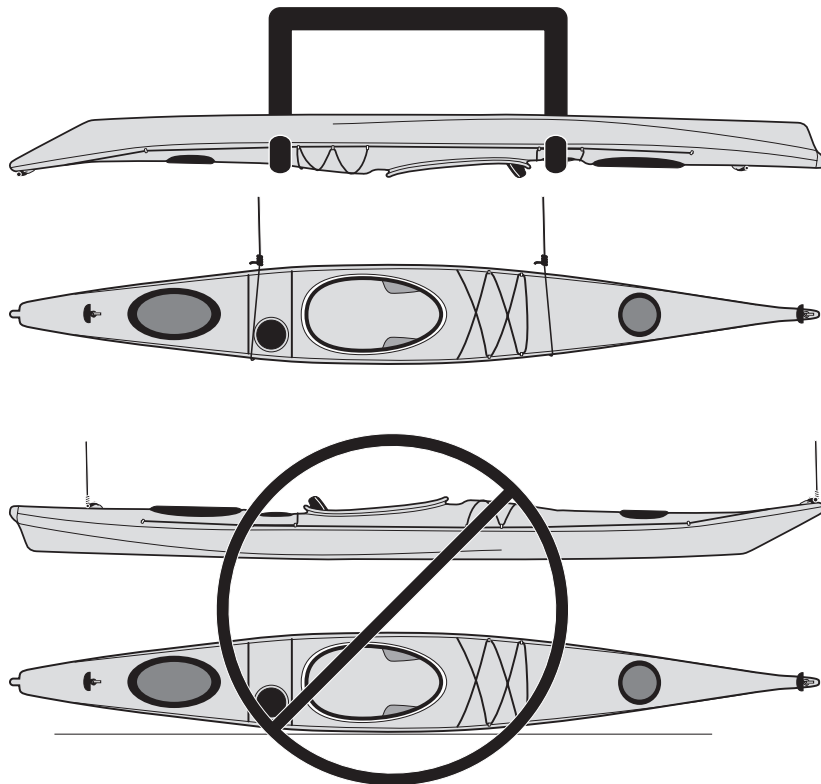

ROOF RACK

A kayak carrier, or “J cradle” for your vehicle is the best method of transporting a kayak. It should be lashed down at each crossbar, as well as at the bow and stern to each end of the vehicle. Kayak cradles are recommended for boats being transported “flat” to lessen chances of deformation from being lashed too tightly to the bars.

Rotomolded kayaks can be transported on their edge or upside down (hull up) safely using kayak stackers. For Composite kayaks we recommend that they be transported on their bottom using cradles to prevent deformation. Be careful not to over tighten straps as this could cause deformation in your boat.

USING FOAM BLOCK RACKS

Foam block racks can be used for transporting kayaks if extreme caution is practiced in rigging the load. They should be wide enough for adequate support. The boats must be securely attached to the top of the vehicle through the doors or windows and attached securely to both the front and back of the vehicle. If these tie down points at the front and back aren’t available on your vehicle, foam block racks should NOT be used.

INCLEMENT WEATHER

If traveling when inclement weather is threatening, position the kayak upside down if possible. A kayak heavy with water can become dangerous. Use a portage cover to seal the cockpit if an upside down position is not possible. Periodically check your straps to ensure they have not stretched while wet.

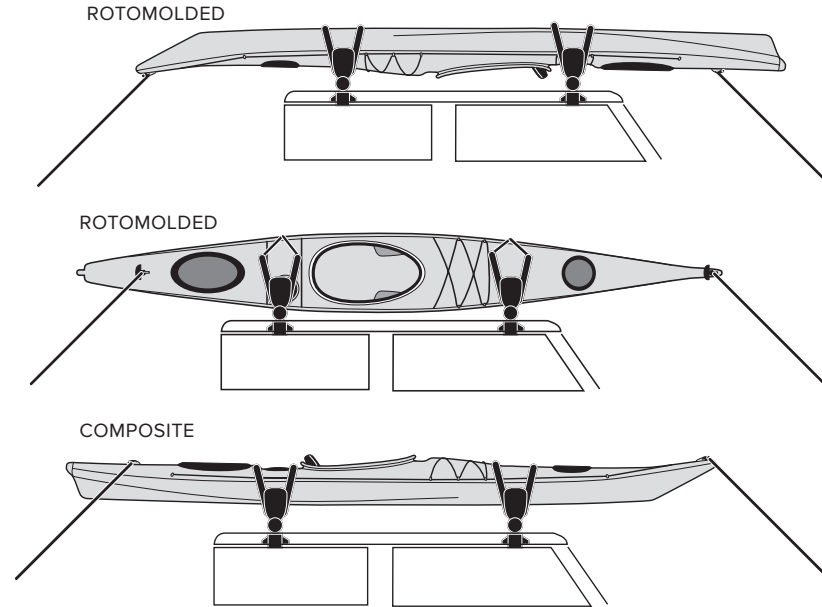

CAUTION:

Always check your tie down rigging often as ropes and straps may loosen in transport.

IMPORTANT:

Commander Series requires special transportation instructions. Please see separate Commander Series Addendum.

ROTOMOLDED KAYAK CARE

Our “roto” kayaks are made of high-density linear polyethylene, which is virtually maintenance free. A minimal amount of care in storage and transporting will help the kayak maintain a like-new condition for many years.

Polyethylene will become more flexible in warm conditions such as a hot, sunny day. It is possible for a kayak strapped tightly to a roof rack to deform at the weight bearing points. Use a padded rigid bar sport rack in addition to a kayak J cradle or saddles to disperse the weight.

COMPOSITE KAYAK CARE

Composite kayaks (PRO models), made of a fiberglass or Kevlar laminate, require a small amount of additional care over rotomolded kayaks. Scratches or superficial damage can be buffed with rubbing compound and followed with a polishing compound. Gel coat repair kits are also available from your Wilderness Systems dealer for more extensive repairs.

Hard impacts may result in structural damage, so inspect your hull after a collision. Inspect the interior of the hull at the location corresponding to the impact. Look for fine white lines mirroring any damage on the outside of the hull. This may indicate a resin fracture. In some cases this may require a composite repair kit available from your Wilderness Systems dealer.

CLEANING

Usually, a quick rinse of fresh water is all that is necessary to keep your hull clean and functioning in good order. This is very important after paddling in salt water, especially if your boat is outfitted with a rudder system. Be sure to thoroughly rinse the rudder, rudder cables, and footbraces with fresh water to remove salt residue.

Superficial scratches may occur, but can be removed or reduced by use of a marine boat polish designed for polyethylene hulls. Sanding or use of an abrasive rubbing compound is not recommended.

To keep your kayak shining and minimize long-term degradation caused by UV exposure, use an ultraviolet protectant such as 303 Protectant. 303 can also be used lightly on the top of the hatches and on the seat outfitting and plastic buckles and straps, in addition to the kayak itself. 303 is available at your local Wilderness Systems dealer or online at harmonygear.com

WARNING:

Avoid dragging kayak across the ground to prolong its life and maintain its look and performance. Two people, utilizing the carrying handles, is the best way to transport the boat. Alternately, you can transport using a kayak cart, available at your dealer or at harmonygear.com.

Any person using kayaks built and/or sold by Wilderness Systems is personally responsible for determining that their abilities are equal or superior to the conditions encountered and exercising proper judgment in choice of where and when to paddle.

Any person using Wilderness Systems kayaks assumes all risks and takes complete responsibility for any and all damages, or injuries, including death, which may result from use of or participation in Wilderness Systems kayaks. Consult your physician prior to beginning your paddlesport training.

DO:

- Wear a Coast Guard approved personal flotation device (PFD).
- Wear a helmet when paddling whitewater or in the ocean.
- Get paddlesports instruction from a licensed or certified instructor.
- Dress appropriately for weather conditions; cold water and/or weather can result in hypothermia.
- Check your equipment prior to each use for signs of wear or failure.
- Scout unfamiliar waters. If necessary, paddle to shore and carry your boat past uncertain areas.
- Stay aware of appropriate river water levels, tidal changes, dangerous currents, and weather changes.
- Follow manufacturer's recommendations for use and outfitting of your kayak.
- Leave your paddling location and agenda with someone at home before departing.
- Obtain certified first-aid and rescue training and carry first-aid and rescue equipment.

DON'T:

- Never exceed your ability and assess how far and how long you can paddle or swim.
- Never paddle alone.
- Never consume alcohol, drugs, or any other substance that may affect your coordination, judgment, or ability when paddling.
- Never paddle in flood conditions.
- Never allow minors to use the boat without adult supervision.
- Avoid bracing yourself in the kayak in such a way that you have to release any outfitting to escape.
- Do not impair entry or exit access to the kayak when installing additional outfitting.

WARNING:

Kayaking can be hazardous with potential risk of serious injury and even death.

ESSENTIALS CHECKLIST:

PERSONAL FLOTATION DEVICE (PFD)

A USCG approved, comfortable and secure fitting PFD should be worn at all times. Shorter PFDs are available that are ideal for kayak paddling.

PADDLE

Choosing a paddle is almost as important as your choice of boat. Blade shape, length, weight, and material all offer different experiences. On longer trips, it is strongly recommended that you have a spare paddle that can be easily stowed on your deck.

For a listing of premium touring paddles, visit atpaddles.com

SAFETY EQUIPMENT

USCG regulations require an audible signal device (horn or whistle) to be used in all watercraft. In addition, it is recommended that all paddlers carry and know how to use a bilge pump, to drain water from the kayak and a paddlefloat for a solo re-entry. Be sure to secure training in the operation of a paddlefloat.

PERSONAL GEAR

There are many items that you may wish to take with you on a paddling trip. Your location, length of journey, group size, weather, etc. will all play a part in this “essentials list”.

- Drinking water
- Snacks
- Extra clothes in a drybag
- Map or chart
- First-Aid
- Matches
- Sun protection

To help you learn about the logistics of a paddling trip and correct paddling technique we strongly recommend a good beginner level paddling course from a certified instructor.

OTHER ACCESSORIES:

There are a wide variety of accessories designed for your kayak to enhance the performance and overall experience. Not all accessories are available for all models.

SPRAYSKIRT

For longer trips or rougher conditions, a sprayskirt is worn by the paddler to create a watertight seal, preventing the cockpit from filling up with water.

DRY BAG

Ultra-light and water-resistant storage for an extra level of protection and accessibility for gear.

A COMPLETE LINE OF OUR ACCESSORIES CAN BE
FOUND ONLINE AT [HARMONYGEAR.COM](https://www.harmonygear.com)

ANGLER ACCESSORIES

Angler versions are customized for each model and include all or some of the following accessories:

- YAKATTACK™ Zooka Tube Rod Holder
- YAKATTACK™ Mighty Mounts (2)
- YAKATTACK™ Screwball (2-3 depending on model)
- YAKATTACK™ VISICarbon Pro Flag/Light

LIMITED LIFETIME WARRANTY

TERMS AND CONDITIONS

For the original retail purchaser ("Consumer"), Wilderness Systems kayaks by Confluence Outdoor provide a lifetime warranty against material or manufacturing defects in the hull and deck.

Parts, accessories, and outfitting are warranted for a period of one (1) year against material or manufacturing defects from the date of purchase.

For Wilderness Systems kayaks sold as "2nd Quality" as indicated on the Manufacturer's Statement of Origin (MSO), Confluence Outdoor provides this limited warranty for five (5) years for the hull and deck and one (1) year for parts, accessories, and outfitting.

This limited warranty is only valid with the purchase of a Wilderness Systems kayak from an Authorized Wilderness Systems Dealer. This warranty is non-transferable.

HOW TO REGISTER YOUR BOAT

The warranty registration form should be completed online at WildernessSystems.com within 30 days of original purchase to be activated. It is suggested that you keep your sales receipt should it be required in the future for proof of purchase.

OBTAINING WARRANTY SERVICE

If you have a problem with your kayak and you suspect that it may be due to defective materials or workmanship, contact the nearest authorized Wilderness Systems kayak dealer and arrange to have the problem inspected. Consumer is responsible for delivery to, and pickup from, the closest authorized dealer.

If the authorized Wilderness Systems dealer's inspection indicates a defect that is attributable to materials or workmanship, Confluence Outdoor will repair or replace your Wilderness Systems kayak free of charge at the company's option. Proof of purchase such as a sales

receipt may be required. If repairs or evaluation are required by Wilderness Systems at its manufacturing facility, the Consumer will be responsible for a \$50.00 shipping and handling fee.

If service is required in a country that is not the country of purchase, Consumer will comply with all applicable export laws and regulations and be responsible for all customs duties, value add tax (VAT), and other associated taxes and charges. For international service, the Wilderness Systems Distributor may repair or exchange defective products and parts with comparable products and parts that comply with local standards.

Confluence Outdoor retains the right to satisfy warranty via repair or replacement of products or of components deemed defective. In addition, Wilderness Systems reserves the right to replace original kayaks or equipment with comparable current products.

LIMITATIONS AND EXCLUSIONS

This limited warranty does not apply to:

- Normal wear and tear and aging of product.
- Kayaks damaged by extreme weather or environmental conditions.
- Kayaks damaged while in possession of a freight carrier, a dealer, Consumer, or any party other than Wilderness Systems.
- Kayaks damaged by accident, neglect, improper use or handling.
- Kayaks that have been towed by power or sail boats.
- Kayaks designated as Prototypes.
- Kayaks sold as "demos" or in "as is" condition.
- Kayaks determined to have been used for any activity other than an activity which is customary for the product.

- Kayaks that have been structurally or dimensionally altered or modified.
- Kayaks used for commercial or rental purposes.

This limited warranty excludes all other warranties, expressed or implied, including implied warranties of merchantability and fitness for a particular purpose, with regard to Wilderness Systems Kayaks. Some state, country, or provincial laws do not allow the exclusion of certain implied warranties, so the above exclusion may not apply to you.

This limited warranty excludes any incidental or consequential damages or expenses resulting from any defects. Confluence Outdoor's aggregate liability shall be limited to an amount equal to Consumer's original purchase price paid for the defective product. Some state, country, or provincial laws do not allow the exclusion or limitation of incidental or consequential damages, so the above exclusion may not apply to you.

To the extent any limitation or exclusion contained herein is contrary to any country, state, or provincial law, such limitation or exclusion shall be severable and all other terms herein shall remain in full force and effect and are valid and enforceable.

This warranty gives you specific legal rights and you may also have other rights. For Consumers who are covered by state, country or provincial consumer protection laws or regulations, the benefits from this warranty are in addition to all rights conveyed by such consumer protection laws and regulations.

FINDING YOUR SERIAL NUMBER

The serial number is located near the stern (rear) of the boat, just below the line where the deck and side meet. On most boats it is engraved in an indentation on the right side of the boat.

NOTICE: STATE REGULATIONS

Some states require that all kayaks be registered. To register your kayak you will need your Manufacturer's Statement of Origin (MSO). This serves as the title to your kayak and should have been provided when you took delivery. If not, check with your retailer. If it has been lost, have your dealer contact Wilderness Systems and we will provide a replacement.

Note: Make sure the serial number on your MSO matches that on your hull.

QUESTIONS?

Visit WildernessSystems.com to answer these and many other commonly asked questions about our kayaks and accessories:

How do I adjust the seat?

How do I move the footbraces for solo paddling?

How do I install the rudder?

How can I get replacement parts?

What other accessories are available for my kayak?

IMPORTANT INFORMATION

Boat Model: _____

Serial Number: _____

Date of Purchase: _____

Dealer Name: _____

SERVICE AND SUPPORT

If you have a problem with your kayak that you believe is covered under warranty, contact the nearest authorized Wilderness Systems dealer. You can find a listing of all dealers on our website.

If you have additional questions about your kayak or accessories, please visit our online support webpage at WildernessSystems.com for resources or to find information on contacting a customer service representative.

CONTACT US

(p) 888-52-KAYAK (888-525-2925)

(f) 888-373-1220

Service and support hours are Monday through Friday from 9 a.m. to 5:30 p.m. EST.

All warranties and part orders need to be handled through an authorized dealer, we do not sell direct.

©2014 Confluence Outdoor

Confluence Outdoor
575 Mauldin Road, Suite 200
Greenville, SC 29607
WildernessSystems.com