

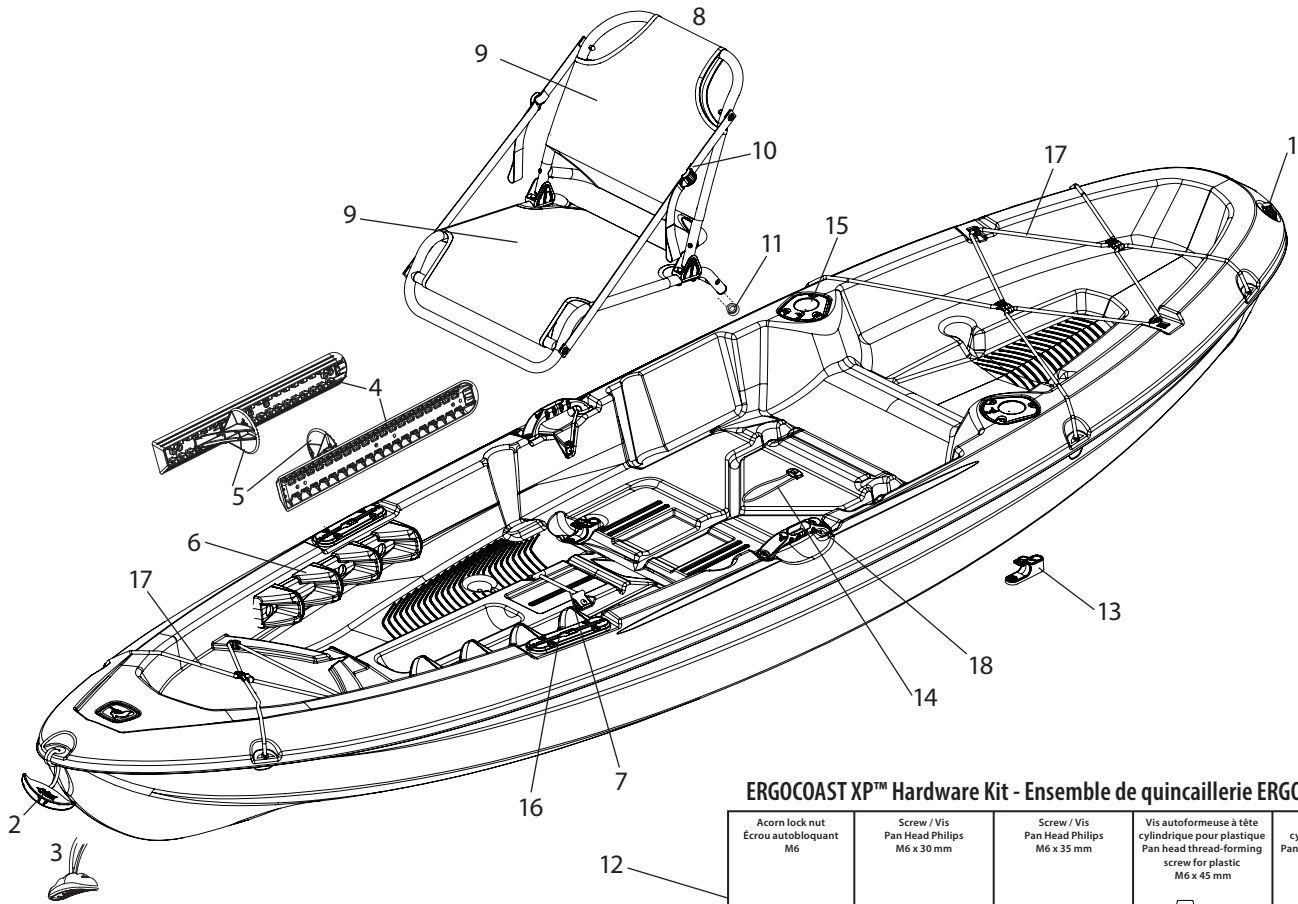







10 ft (3.05 m) SIT-ON-TOP KAYAKS KAYAKS À COCKPIT OUVERT DE 3,05 m (10 pi)



ERGOCAST XP™ Hardware Kit - Ensemble de quincaillerie ERGOCAST XP™

Acorn lock nut Écrou autobloquant M6	Screw / Vis Pan Head Phillips M6 x 30 mm	Screw / Vis Pan Head Phillips M6 x 35 mm	Vis autoformeuse à tête cylindrique pour plastique Pan head thread-forming screw for plastic M6 x 45 mm	Vis à tête à tête cylindrique Phillips Pan head Phillips sheet metal screw M2.9 x 9.5 mm
				
6X	4X	2X	4X	4X

Seat spacer Rondelle d'espacement	Junction Tube Tube de jonction CT1922-1	Ergo360/ErgoCoast Fork Fourche Ergo360/ErgoCoast
		
2X	2X	2X

NOTE:
Not all models are equipped with the parts listed above.
All accessories are branded Pelican and designed to fit perfectly on your Pelican kayak. For any additional information contact customer service at 1 888 669-6960 or write to us at service@pelicansport.com.

NOTE :
Certains modèles ne sont pas équipés des pièces ci-dessus.
Tous les accessoires sont de marque Pelican et ont été conçus pour s'adapter parfaitement à votre kayak Pelican. Pour toutes informations additionnelles contactez le service à la clientèle au 1 888 669-6960 ou écrivez-nous à service@pelicansport.com.

REPLACEMENT PARTS LIST • LISTE DES PIÈCES DE REMPLACEMENT

- | | |
|--|--|
| <p>1. 1/2 in. (1.27 cm) drain plug •
Bouchon de drain de 1,27 cm (1/2 po)
PS1275</p> <p>2. Standard carrying handles •
Poignées de transport standard
PS1584 PS1669
Yellow Green Black
Citrine Noir</p> | <p>3. Ergonomic T-handles • Poignées de transport en T
PS1573 PS1473 PS1547
Bright Orange Electric Blue Yellow Green
Orange vif Bleu électrique Citrine</p> <p>4. Adjustable footrests • Appui-pieds ajustables
PS0540-2</p> <p>5. Footrests • Appui-pieds
PS1082</p> |
|--|--|

REPLACEMENT PARTS LIST • LISTE DES PIÈCES DE REMPLACEMENT (CONTINUED • SUITE)

- | | |
|---|---|
| <p>6. Non-adjustable molded footrests •
Appui-pieds moulés non-ajustables
PS1759</p> <p>7. 3.75 in. (9.5 cm) bungee cords with strap •
Cordages élastiques avec strap de 9,5 cm cm (3,75 po)
PS3004
Bright orange
Orange vif</p> <p>8. ERGOCOAST XP™ portable seat • Banc portatif ERGOCOAST XP^{MC}
PS3001</p> <p>9. ERGOCOAST XP™ Seat cover for portable seat •
Housse pour banc portatif ERGOCOAST XP^{MC}
PS3005</p> <p>10. ERGOCOAST™ Straps • Courroies d'ajustement ERGOCOAST^{MC}
PS1896</p> <p>11. ERGOCOAST™ end-caps •
Embouts tube de la structure du banc ERGOCOAST^{MC}
PS1885</p> <p>12. ERGOCOAST™ hardware kit •
Ensemble de quincaillerie ERGOCOAST^{MC}
PS3015</p> | <p>13. ERGOCOAST XP™ lock seat • Loquet ERGOCOAST XP^{MC}
PS1329</p> <p>14. 13.5 in. (34.3 cm) bungee cord with cable tie down •
Cordage élastique avec attache cable de 34,3 cm (13,5 po)
PS3007
Black
Noir</p> <p>15. Flush mount rod holder • Porte-canne encastré
PS1611 PS0649-3-00
Bright Orange Black
Orange vif Noir</p> <p>16. 4 in. (10.2 cm) rigging track •
Rail de gréement de 10,2 cm (4 po)
PS3047 PS3114-00
Installation avec 8 vis Installation avec 6 vis
Installation with 8 screws Installation with 6 screws</p> <p>17. 38 in. (96.5 cm) bungee cords with plastic clip •
Cordages élastiques avec attache plastique de 96,5 cm (38 po)
PS3008
Bright orange
Orange vif</p> <p>18. Side rigid carrying handle with bungee •
Poignée de transport latérale rigide avec élastique
PS3002</p> |
|---|---|