

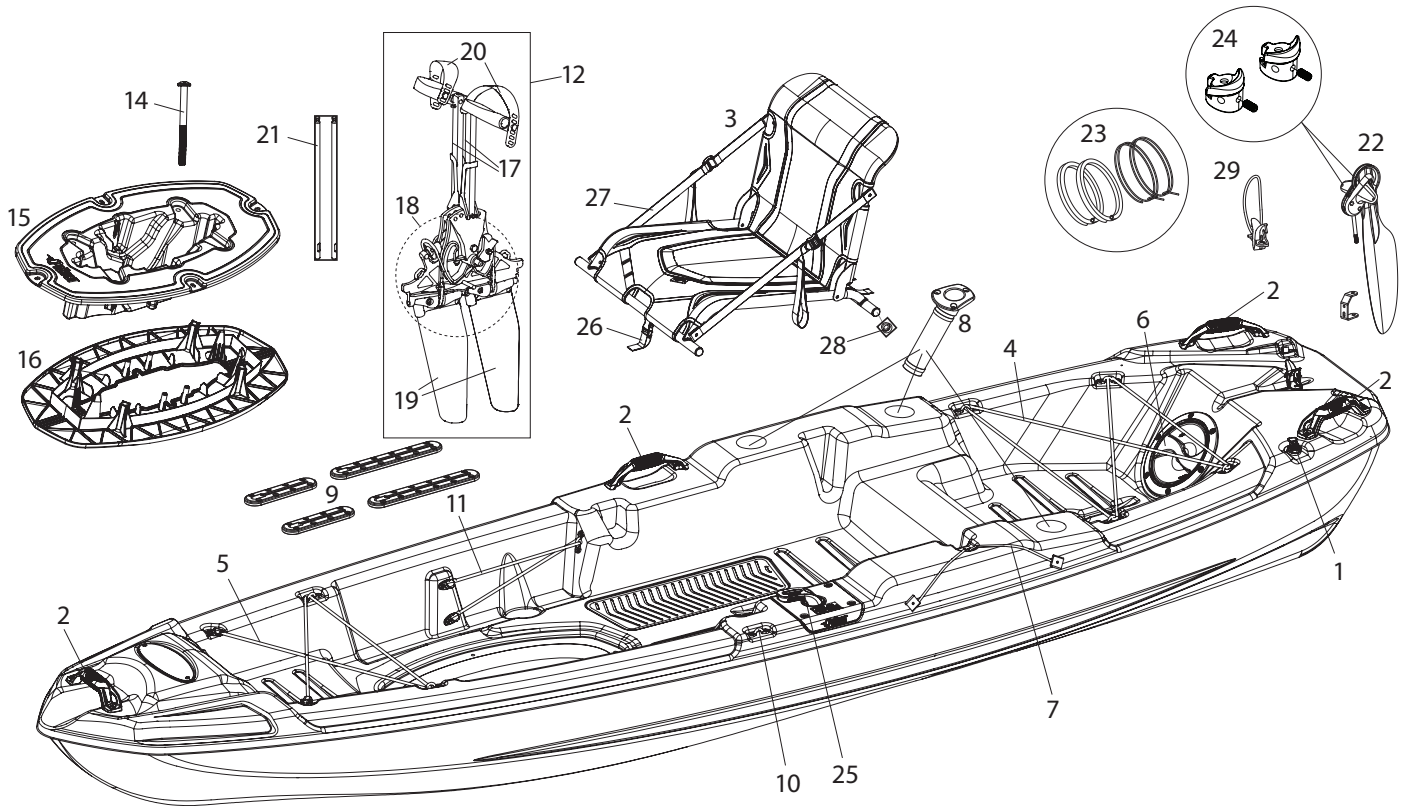







# 10-ft 6-in. (3.2 m) SIT-ON-TOP FISHING KAYAKS KAYAKS DE PÊCHE À COCKPIT OUVERT DE 10 pi 6 po (3,2 m)

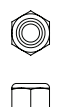

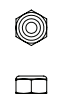
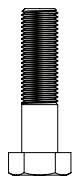
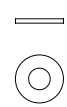
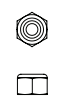
Pedal drive HYDRIVE II™ Hardware Kit - Ensemble de quincaillerie du Système d'entraînement HYDRIVE II™

<p>Flat washer Rondelle plate 1/4" (3/4+00)</p>  <p>2X</p>	<p>Locknut Écrou autobloquant 1/4-20</p>  <p>8X</p>	<p>Phillips rounded head screw Vis Phillips tête ronde 4-40 x 1-1/2"</p>  <p>2X</p>	<p>Locknut Écrou autobloquant 4-40</p>  <p>2X</p>	<p>Hex head screw Vis à tête hexagonale 3/8"-24 x 1-1/2"</p>  <p>2X</p>	<p>Flat washer Rondelle plate 1/4" (5/8+00)</p>  <p>2X</p>	<p>Locknut Écrou autobloquant 8-32</p>  <p>2X</p>	<p>Phillips rounded head screw Vis Phillips tête ronde 8-32 x 5/16"</p>  <p>2X</p>	<p>Flat-tip set screw Vis de réglage à pointe plate 1/4"-20 x 3/8"</p>  <p>4X</p>	<p>Socket head screw Vis à tête hexagonale 8-32 x 1/2"</p>  <p>2X</p>	<p>Phillips rounded head screw Vis Phillips tête ronde 8-32 x 5/8"</p>  <p>2X</p>
--	--	--	--	--	---	--	---	--	--	--

**NOTE:**  
Not all models are equipped with the parts listed above.  
All accessories are branded Pelican and designed to fit perfectly on your Pelican fishing kayak. For any additional information contact customer service at 1-888-669-6960 or write to us at [service@pelicansport.com](mailto:service@pelicansport.com).

**NOTE :**  
Certains modèles ne sont pas équipés des pièces ci-dessus.  
Tous les accessoires sont de marque Pelican et ont été conçus pour s'adapter parfaitement à votre kayak de pêche Pelican. Pour toutes informations additionnelles contactez le service à la clientèle au 1-888-669-6960 ou écrivez-nous à [service@pelicansport.com](mailto:service@pelicansport.com).

## REPLACEMENT PARTS LIST • LISTE DES PIÈCES DE REMPLACEMENT

- |  |   |
|--|---|
| <p>1. 11/16 in. (1.75 cm) Drain Plug •<br/>Bouchon de drain de 1,75 cm (11/16 po)<br/><b>PS0145-2</b></p>  | <p>14. HyDryve II™ Housing - Long Screw •<br/>Vis long pédalier HyDryve II<sup>MC</sup><br/><b>PS0005</b></p>               |
| <p>2. Rigid Carrying Handles G2 • Poignées de transport rigides G2<br/><b>PS1736</b></p>   | <p>15. HyDryve II™ Housing - Top •<br/>Boîtier du HyDryve II<sup>MC</sup> - Dessus<br/><b>PS1847</b></p>                    |
| <p>3. ERGOCAST G2™ Seating System •<br/>Système d'assise ERGOCAST G2<sup>MC</sup><br/><b>PS1733</b><br/>Black/Grey<br/>Noir/Gris</p>   | <p>16. HyDryve II™ Housing - Bottom •<br/>Boîtier du HyDryve II<sup>MC</sup> - Dessous<br/><b>PS1848</b></p>                |
| <p>4. 88 in. (224 cm) Bungee Cord •<br/>Cordage élastique de 224 cm (88 po)<br/><b>PS1843</b><br/>Bright orange<br/>Orange vif</p>   | <p>17. HyDryve II™ Pedal Arm •<br/>Bras de pédale du système d'entraînement HyDryve II<sup>MC</sup><br/><b>PS1875</b></p>   |
| <p>5. 64 in. (163 cm) Bungee Cord • Cordage élastique de 163 cm (64 po)<br/><b>PS1682</b><br/>Bright orange<br/>Orange vif</p>   | <p>18. HyDryve II™ Core Mechanism •<br/>Mécanisme du système d'entraînement HyDryve II<sup>MC</sup><br/><b>PS1849-2</b></p> |
| <p>6. 8 in. (20 cm) Day-hatch with Storage Bag •<br/>Compartiment de 20 cm (8 po) avec sac de rangement<br/><b>PS0411</b></p>  | <p>19. HyDryve II™ Fin and Rod •<br/>Aileron du système d'entraînement HyDryve II<sup>MC</sup><br/><b>PS1876-2</b></p>      |
| <p>7. Paddle and Rod Tie-down •<br/>Porte-pagaie et porte-canne<br/><b>PS1511</b><br/>Black<br/>Noir</p>   | <p>20. HyDryve II™ Pedal Only •<br/>Pédale du système d'entraînement HyDryve II<sup>MC</sup><br/><b>PS1874</b></p>          |
| <p>8. Flush Mount Rod Holder • Porte-canne encastré<br/><b>PS1611</b>    <b>PS0649-3-00</b><br/>Bright orange    Black<br/>Orange vif    Noir</p>  | <p>21. HyDryve II Fin rods • Tiges pour aileron HyDryve II<br/><b>PS1930-2</b></p>  |
| <p>9. 8 in. (20.3 cm) rigging track •<br/>Rail de gréement de 20,3 cm (8 po)<br/><b>PS3048</b>    <b>PS3115-00</b><br/>Installation with 12 screws    Installation with 10 screws<br/>Installation avec 12 vis    Installation avec 10 vis</p> <p>4 in. (10.2 cm) rigging track •<br/>Rail de gréement de 10,2 cm (4 po)<br/><b>PS3047</b>    <b>PS3114-00</b><br/>Installation with 8 screws    Installation with 6 screws<br/>Installation avec 8 vis    Installation avec 6 vis</p> | <p>22. Rudder • Gouvernail<br/><b>PS1880</b></p>  |
| <p>10. Accessory Eyelet • Oeillet de fixation d'accessoires<br/><b>PS1210</b></p>  | <p>23. Rudder Cable • Câble pour gouvernail<br/><b>PS1841</b></p>   |
| <p>11. Elastic Bungee Cord 24 in. (61 cm) Bottle holder •<br/>Cordage élastique porte bouteille 61 cm (24 po)<br/><b>PS1593</b><br/>Bright orange<br/>Orange vif</p>   | <p>24. Rudder Transition supports • Supports de transition gouvernail<br/><b>PS1871</b></p>                                 |
| <p>12. Complete HyDryve II™ Pedal System •<br/>Système d'entraînement HyDryve II<sup>MC</sup><br/><b>PS1846-2</b></p>  | <p>25. Tiller with Rudder Cables • Manette avec câble gouvernail<br/><b>PS1842</b></p>                                      |
| <p>13. HyDryve II™ Hardware Kit •<br/>Kit de Quincaillerie du Système d'entraînement HyDryve II<sup>MC</sup><br/><b>PS1830</b></p>   | <p>26. Seat Tie-Down Strap • Courroie pour coussin d'assise<br/><b>PS1510</b></p>   |
|  | <p>27. Adjustable Strap • Courroie latérale pour système d'assise<br/><b>PS1340</b></p>                                     |
|  | <p>28. ERGOCAST G2™ End Caps •<br/>Embout de la base du banc ERGOCAST G2<sup>MC</sup><br/><b>PS1885</b></p>                 |
|  | <p>29. Rudder holder • Porte-gouvernail<br/><b>PS1274</b></p>   |

## ASSEMBLY INSTRUCTIONS • INSTRUCTIONS D'ASSEMBLAGE

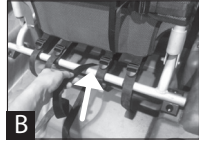
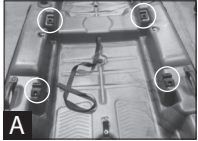

### HOW TO INSTALL THE SEATING SYSTEM?

- A) Place the seat into position.
- B) Pass the strap over the top of the front and rear bars.
- C) Pass the strap through the front metal clip and tighten.

**TRANSPORTATION RECOMMENDATION:** We strongly recommend removing the seat before transporting the kayak.

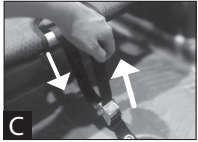

### COMMENT POUVEZ-VOUS INSTALLER LE SYSTÈME D'ASSISE ?

- A) Placez le système d'assise en position.
- B) Passez la courroie au-dessus des tubes avant et arrière.
- C) Passez la courroie dans la boucle de métal avant et serrez la courroie.

**RECOMMANDATIONS DE TRANSPORT :** Nous recommandons fortement d'enlever le siège du kayak lorsque vous le transportez.



Final assembly / Assemblage final

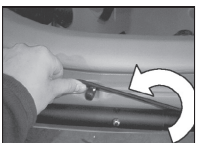

### HOW TO USE THE PADDLE TIE-DOWN?

Place the paddle into the molded space located on the side of the kayak, pass the bungee cord over the paddle and attach it to the hook.

### COMMENT POUVEZ-VOUS UTILISER LE PORTE-PAGAIE ?

Déposez la pagaie dans l'espace moulé située sur le côté du kayak, passez le cordon élastique par-dessus la pagaie et attachez-le au crochet.